



# **SEPLoS 48V 200A BMS**

## **User Manual**

Please read this manual carefully before operating  
and retain it for future reference.

## Content

1. Application.....	- 1 -
2. Functions.....	- 1 -
2.1 The detection of individual cell and battery pack.....	- 1 -
2.2 The detection of cell, ambient and chip temperature.....	- 1 -
2.3 The detection of charge and discharge current.....	- 2 -
2.4 Short-circuit protection.....	- 2 -
2.5 SOC calculating and cycle life counting.....	- 2 -
2.6 Charge and discharge MOSFET.....	- 3 -
2.7 Equalization of individual cell.....	- 3 -
2.8 LED indicator.....	- 3 -
2.9 Auto sleeping function.....	- 3 -
2.10 Power ON/OFF.....	- 4 -
2.11 CAN and RS485 communication.....	- 4 -
2.12 Communication between paralleled packs.....	- 5 -
2.13 Record, storage and read historical data.....	- 5 -
2.14 Setup parameters.....	- 5 -
2.15 Functions management.....	- 6 -
2.16 Pre-charge.....	- 6 -
2.17 Resistance compensation of connector.....	- 6 -
2.18 Charging current limitation.....	- 7 -
2.19 Upper computer system.....	- 8 -
2.20 Program upgrading.....	- 8 -
3. Function Diagram.....	- 9 -
4. Electric features.....	- 9 -
5. Basic parameters.....	- 9 -
5.1 Setup parameters.....	- 9 -
5.2 Power consumption.....	- 18 -
5.2.1 Charging mode.....	- 18 -
5.2.2 Discharging mode.....	- 18 -
5.2.3 Standby mode.....	- 18 -
5.2.4 Power off mode.....	- 18 -
5.3 LED indicator.....	- 19 -
5.3.1 LED lights.....	- 19 -
5.3.2 Capacity indicators.....	- 19 -
5.3.3 Lights blinking explanation.....	- 20 -
5.3.4 Running status indicators.....	- 20 -
6. Functions.....	- 21 -
6.1 Standby.....	- 21 -
6.2 Over charging protection and recovery.....	- 21 -

6.2.1 over charging protection and recovery of individual cell.....	- 21 -
6.2.2 Over charging protection and recovery of total voltage.....	- 21 -
6.3 Over discharge protection and recovery.....	- 22 -
6.3.1 over discharging protection and recovery of individual cell.....	- 22 -
6.3.2 Over discharging protection and recovery of total voltage.....	- 22 -
6.4 Over charging current protection and recovery.....	- 23 -
6.5 Over discharge current protection and recovery.....	- 23 -
6.6 Temperature protection and recovery.....	- 24 -
6.6.1 High temperature protection and recovery.....	- 24 -
6.6.2 Low temperature protection and recovery.....	- 24 -
6.6.3 Ambient temperature warning and PCB temperature protection....	- 25 -
6.7 Equalization.....	- 25 -
6.8 Power ON/OFF.....	- 25 -
6.9 Storage.....	- 26 -
7. Dimension.....	- 27 -
8. Connections.....	- 28 -
8.1 Definition of wiring.....	- 29 -
8.2 Wiring step.....	- 30 -
9. Communication.....	- 30 -
9.1 CAN communication.....	- 30 -
9.2 RS485 communication.....	- 31 -
9.3 Parallel communication.....	- 31 -
9.4 DIP address.....	- 31 -
9.4.1 RS485 DIP address setup.....	- 32 -
CAN DIP address set.....	- 33 -
10. LCD screen.....	- 34 -
11. Precautions.....	- 35 -

## 1. Application

This is the full-featured Battery Management System (BMS) that designed to monitor 8s-16s battery pack at 200A rate. The BMS offers protection and recovery to individual cell over/under voltage, pack over/under voltage, charge/discharge over current, high/low temperature and short circuit. And accurately calculates the SOC and SOH status. As well as keeps voltage balancing during charging and discharging. And could also monitors parameter settings and data through computer via RS485 interface. (Baud rate 19200. )

## 2. Functions

### 2.1 The detection of individual cell and battery pack

By detecting the cell voltage in real-time, BMS provides over/under voltage warnings and protections. At the temperature of 0 ~ 45°C, the measured voltage difference is about  $\pm 10\text{mV}$ . While at the temperature of -20 ~ 0°C and 45 ~ 70°C, the measured voltage difference is  $\pm 30\text{mV}$ .

### 2.2 The detection of cell, ambient and chip temperature

By detecting the temperature of cells (4 of the 16 cells), ambient temperature, and temperature of PCB board in real-time via NTC, BMS

provides high/low temperature warnings and protections. The measured difference is  $\pm 2^{\circ}\text{C}$ .

Cell temperature sensor NTC value is  $10\text{K}\Omega$ , and B-value at 3435.

The warning and protection threshold value can be configurable through software.

### 2.3 The detection of charge and discharge current

With the current sense resistors in the charging/discharging circuit, BMS detects and monitors the the input and output current in real-time, and provides over current warnings and protections. When the temperature rise is less than  $40^{\circ}\text{C}$ , the measured accuracy is up to  $\pm 1\%$ . The warning and protection current threshold can be configurable through software.

### 2.4 Short-circuit protection

BMS features short-circuit detecting and protecting function.

### 2.5 SOC calculating and cycle life counting

BMS calculates the remaining capacity in real-time. The BMS get the capacity at the first time when the battery pack complete a full charging and discharging cycle. And the SOC calculating accuracy is  $\pm 5\%$ .

BMS counts the number of how many charging/discharging cycles a battery has experienced as aging. When the accumulated discharge capacity is equal to 80% of the design capacity. The cycle count

increases.

The capacity parameters can be configurable through software.

## 2.6 Charge and discharge MOSFET

Low impedance, high current MOSFET is the optimized design for the power-on, zero handoff and charging voltage withstanding for large capacitive loads backup power supply.

## 2.7 Equalization of individual cell

When in charging or standby status, each cell can be equalized. Which will greatly increases battery life span and cycle life.

The voltage and voltage difference threshold value can be configurable through software.

## 2.8 LED indicator

There are 6 LED indicators. 4 white LED indicators for SOC status. 1 red LED indicator for warning, protection, and fault indicating. And 1 white LED for battery standby, charging and discharging status.

## 2.9 Auto sleeping function

BMS features auto sleeping function.

If the battery didn't charge/discharge for 48 hours. The BMS will sleeping automatically.

If the battery is in discharge protection status, and maintains communication for 1 minutes. The BMS will sleeping automatically.

Hold the 'reset' button for 3 seconds. The indicators lighten in order.

And the BMS enters into sleeping.

Sleeping mode function is configurable through software.

## 2.10 Power ON/OFF

Paralleled battery packs could be powered on with one-click.

When the battery packs are connected in parallel, BMS needs to setup address via DIP switch. If the DIP address is correctly set, power on/off the master pack, all the slave packs can be powered on/off together. (If each pack with different voltage, and there's current output between the paralleled packs, slave packs cannot be powered off.)

## 2.11 CAN and RS485 communication

CAN BUS could realize communication between battery and inverter.

And CAN communication has different protocol according to different inverters. (Seplos CAN protocol is compatible with Pylontech and Goodwe protocol.)

RS485 communication could realize data monitoring, operation controlling and parameter setting through computer or other devices via telemetering, telesignalization, remote regulating and remote control

commands.

## 2.12 Communication between paralleled packs

Connect the battery packs through RS485. And setup address with DIP switches.

Two ways to check the paralleled packs information:

Connected the paralleled packs with RS485 interface. Then connected with master computer.

Connected the paralleled packs with RS485 interface. Then connect the master pack with inverter via CAN interface.

## 2.13 Record, storage and read historical data

Each time the battery system changes status, BMS will save the data information, which including warning, protection triggering and releasing data. BMS can also save the data information of a certain period of time by setting start time, end time and time interval.

Up to 300 historical data can be recorded and stored. And all the data can be read, and save as excel through master computer.

## 2.14 Setup parameters

Voltage of individual cell, total voltage, charging and discharging over current, high or low temperature of cell and ambient, cell balancing, the

the numbers of cells in series, battery capacity and other battery management parameters can all be configurable through software.

### 2.15 Functions management

Manage voltage/temperature/current monitoring and controlling functions, as well as capacity calculating function through software.

### 2.16 Pre-charge

The pre-charge function will be activated at the moment when BMS or discharge MOSFET powered on. The pre-charge time range is 1mS - 5000mS. This function will effectively protect BMS from short circuit. And it is specially designed for the application of capacitive load.

### 2.17 Resistance compensation of connector

Long copper bus bars, or wires would cause large voltage difference. If the voltage difference is too large, check the connectors between the two cells. The voltage difference caused by long bus bars and wires could set voltage compensation through upper computer system.

Check the voltage difference between the long bus bars, or wires when discharging, and calculate the resistance compensation according to  $\text{resistance} = \text{voltage difference} / \text{current}$ . And set the resistance value with upper computer system. The default resistance compensation is between the anode of 8<sup>th</sup> battery and cathode of 9<sup>th</sup> battery. Another

two resistance compensation reserved for special occasions.

## 2.18 Charging current limitation

There are two kinds of current limitation to meet different needs. That is active current limitation and passive current limitation.

Active current limitation: When at the charging status, the current limitation MOSFET keeps being connected. And the charging current will be limited to 10A. Passive current limitation: When at the charging status, the charging MOSFET keeps being connected. Once the charging current reaches over current warning threshold (The default threshold value is 200A.), the charging current limitation will be activate. And the charging current will decrease to 10A. BMS will detect the charging current every 5 minutes, and check whether the charging current could activate passive current limitation. (The default passive current limitation threshold is edible. )

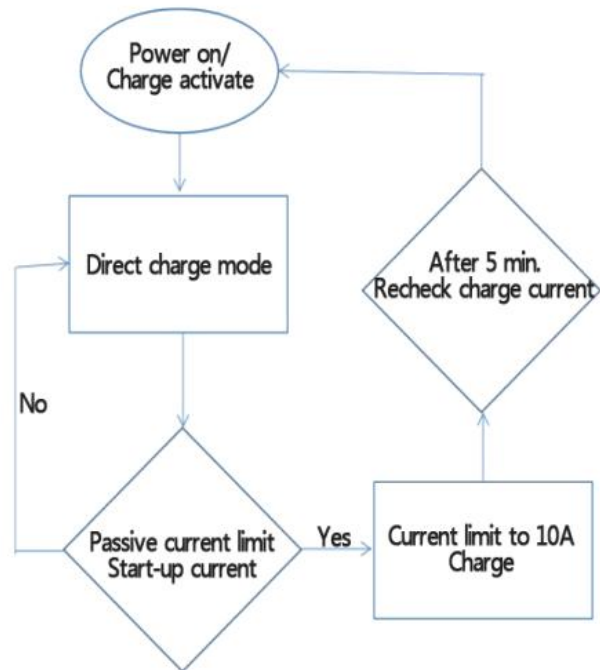

## 2.19 Upper computer system

Software name is Battery Monitor. It is available in Chinese and English. (Load the corresponding language agreement.) Check the installation guide for installation.

Download the software with this link:

<https://drive.google.com/drive/folders/10pxgNLHovcDZRVGrCZsSkfecBrRw-AdW?usp=sharing>

## 2.20 Program upgrading

Upgrade the software with 'Update' program via RS485 interface.

### 3. Function Diagram

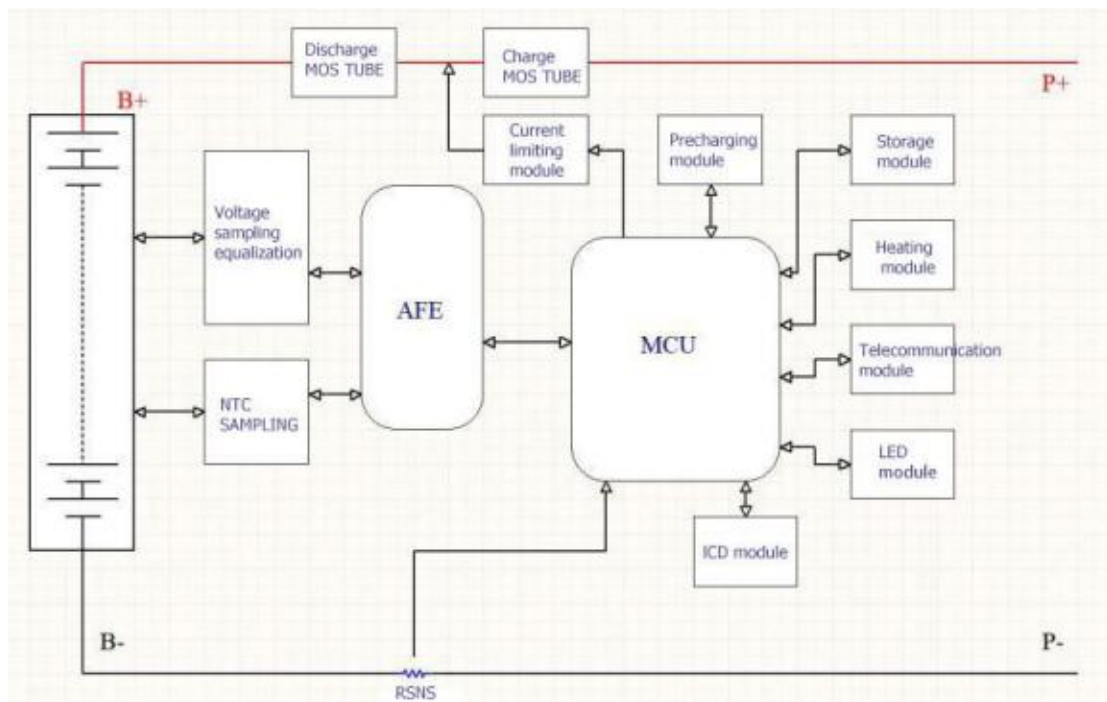

### 4. Electric features

Item	Min.	Max.	Type
Standard working voltage	41V	59V	48V
Standard charging voltage	30V	60V	54V
Working temperature range	-20°C	70°C	25°C
Continuously charging current			200A
Continuously discharging current			200A
Discharge output impedance	< 2mΩ		
Power consumption	< 40mA		
Sleeping mode power consumption		50uA	0uA

### 5. Basic parameters

#### 5.1 Setup parameters

Functions	Status		Default	Configurable Range
-----------	--------	--	---------	--------------------

Individual cell voltage warning	ON	Over voltage warning	3500mV	Over voltage warning recovery - over voltage protection
		Over voltage warning recovery	3400mV	3000mV - over voltage warning
		Under voltage warning	2900mV	Under voltage protection - under voltage warning recovery
		Under voltage warning recovery	3000mV	Under voltage warning - 3300mV
Individual cell over voltage protection	ON	Over voltage protection	3650mV	Over voltage warning - 4500mV
		Over voltage protection recovery	3400mV	Over voltage warning recovery - over voltage protection
		Over voltage recovery condition	1. Individual cell voltage decrease to over voltage recovery threshold. 2. The remaining capacity lower than 96% of the intermittent power supply. <b>Both conditions should be satisfied.</b>	
			Output current $\geq 1A$	
Individual cell under voltage protection	ON	Under voltage protection	2700mV	1500mV - under voltage protection recovery
		Under voltage protection recovery	2900mV	Under voltage protection - under voltage warning
		Under voltage protection condition	When an individual cell gets under voltage protection threshold, BMS maintain communication with inveter for 1 minutes and powered off.	
		Under voltage protection recovery	Input current $\geq 1A$	
Total voltage warning	ON	Over voltage warning	56.0V	Over voltage warning recovery - over voltage protection
		Over voltage warning recovery	54.0V	53.0V - over voltage warning

	ON	Under voltage warning	46.4V	Under voltage protection - under voltage warning recovery
		Under voltage warning recovery	48.0V	Under voltage warning - 55.0V
Over voltage protection (total voltage)	ON	Over voltage protection	57.6V	Over voltage warning - 60.0V
		Over voltage protection recovery	54.0V	Over voltage warning recovery - over voltage protection
		Over voltage protection recovery conditions	1. Individual cell voltage decrease to over voltage recovery threshold. 2. The remaining capacity is lower than 96% of the intermittent power supply. <b>Both conditions should be satisfied.</b>	
			Output current $\geq 1A$	
Under voltage protection (total voltage)	ON	Under voltage protection	41.6V	36.0V - under voltage warning recovery
		Under voltage protection recovery	46.0V	Under voltage protection - under voltage warning
		Under voltage protection condition	When the total voltage gets under voltage protection threshold, BMS maintain communication with inveter for 1 minutes and powered off.	
		Under voltage protection recovery conditions	Input current $\geq 1A$	
Cell temperature (Charging)	ON	High temperature warning (charging)	50°C	High temperature warning recovery - high temperature protection
		High temperature warning recovery (charging)	47°C	35°C - high temperature warning
		High temperature protection (charging)	55°C	High temperature protection recovery - 80°C

		High temperature protection recovery (charging)	50°C	High temperature warning recovery - high temperature protection
		Low temperature warning (charging)	2°C	Low temperature protection - low temperature warning recovery
		Low temperature warning recovery (charging)	5°C	Low temperature warning - 10°C
		Low temperature protection (charging)	-10°C	-20°C - low temperature protection recovery
		Low temperature protection recovery (charging)	0°C	Low temperature protection - low temperature warning recovery
Cell temperature (Discharging)	ON	High temperature warning (discharge)	52°C	High temperature warning recovery - high temperature protection
		High temperature warning recovery (discharge)	47°C	High temperature protection recovery - 80°C
		High temperature protection (discharge)	55°C	High temperature warning recovery - high temperature protection
		High temperature protection recovery (discharge)	50°C	High temperature warning recovery - high temperature protection
		Low temperature warning (discharge)	-10°C	Low temperature protection - low temperature warning recovery
		Low temperature warning recovery (discharge)	3°C	Low temperature warning - 10°C
		Low temperature protection (discharge)	-15°C	-30°C - low temperature protection recovery

		Low temperature protection recovery (discharge)	0°C	Low temperature protection - low temperature warning recovery
Ambient temperature	ON	High temperature warning	50°C	High temperature warning recovery - high temperature protection
		High temperature warning recovery	47°C	-20°C - high temperature warning recovery
		High temperature protection	60°C	High temperature protection recovery - 80°C
		High temperature protection recovery	55°C	High temperature warning recovery - high temperature protection
		Low temperature warning	0°C	Low temperature protection - low temperature warning recovery
		Low temperature warning recovery	3°C	Low temperature warning - 60°C
		Low temperature protection	-10°C	-30°C - low temperature protection recovery
		Low temperature protection recovery	0°C	Low temperature protection - low temperature warning recovery
PCB temperature	ON	High temperature warning	90°C	High temperature warning recovery - high temperature protection
		High temperature warning recovery	85°C	60°C - high temperature warning
		High temperature protection	100°C	High temperature warning - 120°C

		High temperature protection recovery	85°C	High temperature warning recovery - high temperature protection
Current limiting (charging)	OFF	Active current limiting	10A	When the charger current > 10A, current limiting activated.
	ON	Passive current limiting		When the charger current > charging over current warning (configurable), current limiting activated.
			Charging current limiting time delay	5 min
Over current warning (charging)	ON	Over current warning	200A	Charging over current warning recovery - charging over current protection
		Over current warning recovery	195A	0A - charging over current warning
Over current protection (charging)	ON	Over current protection	210A	0A~150A
		Over current protection time delay	10S	Configurable
		Over current protection recovery conditions	1. BMS detects any output discharge current. 2. After 60 seconds, the protection recovers automatically.	
Effective charging current	Charging current (in)		1000mA	
	Charging current (out)		700mA	
Over current warning (discharging)	ON	Over current warning	-205A	Over current protection - over current warning recovery

		Over current warning recovery	-203A	Over current warning - 0A
Over current protection (discharging)	ON	Over current protection	-210A	Transient over current protection - 0A
		Over current protection time delay	10S	Configurable
		Over current protection recovery conditions	1. BMS detects any input charge current. 2. After 60 seconds, the protection recovers automatically.	
Over current protection (Transient)	ON	Over current protection	-300A	Discharge over current protection - 100A
		Over current protection time delay	30mS	Configurable
		Over current protection recovery	1. BMS detects any input charge current. 2. After 60 seconds, the protection recovers automatically.	
	OFF	Over current lock	1. Continuously over current for 2 times. 2. The over current lock times exceeded.	
		Over current lock times	5 times	
		Over current lock release	Connected with charger	
Short circuit protection	ON (Cannot be turn off)	Short circuit protection current value and time delay	Programmed into the software (can not be edited)	
		Short circuit protection recovery	1. BMS detects any input charge current. 2. After 60 seconds, the protection recovers automatically.	
	ON	Short circuit protection lock	1. Continuously short in the output circuit. 2. The over current protection lock times exceeded.	
		Short circuit protection lock times	5 times	
		Short circuit protection lock release	Connected with charger	
Effective	Discharge current (in)		-1000mA	

discharging current	Discharge current (out)		-700mA		
Cell equalization	ON	Standby equalization	When there is no charging and discharging current flow, the standby equalization will be activated.		
		Standby time	10 hours	configurable	
	ON	Charging equalization	When at the charging or float charging status, the charging equalization will be activated.		
	Equalization activate condition	Activate voltage	3350mV	Configurable	
		Activate voltage difference	30mV		
		End voltage	20mV		
	ON	Temperature	According to the temperature range of no equalization (ambient temperature)		
		No equalization high temperature	50°C	Configurable	
		No equalization low temperature	0°C		
	Cell failure	ON	Voltage difference	500mV	Configurable
Voltage difference recovery			300mV		
Capacity	Nominal capacity		200AH	5-200Ah	
	Remaining capacity		Calculated accordingly to the cell voltage	Configurable	
	Cycle life accumulated capacity		20%	Cycle life (configurable)	
	ON	Remaining capacity warning	15%		
	ON	Remaining capacity protection	8%	Output current flow will be cut off.	
Reset button	Power on/activate		When in the standby status, hold the reset button for 1 second. The BMS will be activated. The LED indicators will be lighten in order. Then the BMS enters running status.		

	Power off/sleeping		When in standby or running status (except for charging), hold the reset button for 3 seconds, The BMS enters sleeping mode. The LED indicators will be lighten in order. Then the BMS enters enters sleeping status.	
Pre-charging	2000ms	0-5000ms	The pre-charging function will be activated once the BMS powered on.	
BMS power consumption	ON	Longest standby time	48 hours (Do not connected with charger, and no effective charging current.)	
Heating	OFF	Start heating temperature	0°C	Configurable
		Stop heating temperature	10°C	
		Heating function activated	When connected with charger, and the cell temperature reaches the setting value, the heating function activated. Heating function disabled when at standby and discharge status.	
External switch	OFF	When at the standby status, the BMS can be powered on/off through external switches.		
LCD screen	ON	Monitoring software to check the cell voltage, temperature and current.		
Charging activating	ON	The BMS powered off after under voltage protection. Press the button for recovering from protection status and activate output current.	1 minutes	Configurable
Compensating impedance	Continuously fault impedance	10m Ω	Default value from 8 to 9	Battery connection wire compensating impedance
	Compensation 1	0m Ω	9	Configurable
	Compensation 2	0m Ω	13	

## 5.2 Power consumption

### 5.2.1 Charging mode

When a charger was detected, and the charger voltage is 0.5V+ more than the battery voltage, BMS will turn on the charging MOSFET. And when the charging current reaches the effective charging current value, BMS enters charging mode. At charging mode, charging and discharging MOSFET are both turned on.

### 5.2.2 Discharging mode

When a loads was detected, and the discharging current reaches the effective charging current value, BMS enters discharging mode.

### 5.2.3 Standby mode

When the BMS not in charging mode, nor discharging mode, it enters standby mode.

### 5.2.4 Power off mode

When the battery standby for 48 hours, and the battery is in under voltage protection status, or to press the reset/external switches, then the BMS will enter power off mode.

BMS activation conditions:

1. Charging to activate

2. Activate with 48V voltage

3. Press the power switches







### 5.3 LED indicator

#### 5.3.1 LED lights









One running indicator (Green)

one warning indicator (Red)

and four capacity indicator (Green)

					
SOC				ALARM	RUN

#### 5.3.2 Capacity indicators

Status	Charging				Discharging			
Capacity	L4 	L3 	L2 	L1 	L4 	L3 	L2 	L1 
0-25%	OFF	OFF	OFF	Blink	OFF	OFF	OFF	Green
25%-50%	OFF	OFF	Blink	Green	OFF	OFF	Green	Green
50%-75%	OFF	Blink	Green	Green	OFF	Green	Green	Green
≥75%	Blink	Green	Green	Green	Green	Green	Green	Green
Running 	Green				Blink			

### 5.3.3 Lights blinking explanation

Blink Type	Lighten TIEM	OFF TIME
Blink A	0.25S	3.75S
Blink B	0.5S	0.5S
Blink C	0.5S	1.5S

### 5.3.4 Running status indicators

SYSTEM	RUNNING	RUN	ALM	SOC				REMARK
								
OFF	SLEEPING	OFF	OFF	OFF	OFF	OFF	OFF	OFF
STANDBY	RUNNING	Blink A	OFF	OFF	OFF	OFF	OFF	Standby
CHARGE	RUNNING	Green	OFF	According to the remaining capacity				LED Blink B
	Over current warning	Green	Blink B	According to the remaining capacity				LED Blink B
	Over voltage protection	Blink A	OFF	OFF	OFF	OFF	OFF	
	Temp. And over current protection	Blink A	Blink A	OFF	OFF	OFF	OFF	
DISCHARGE	RUNNING	Blink C	OFF	According to the remaining capacity				
	warning	Blink C	Blink C					
	Temp. Over current, short circuit protection	OFF	RED	OFF	OFF	OFF	OFF	
	Under voltage protection	OFF	OFF	OFF	OFF	OFF	OFF	No discharge

## 6. Functions

### 6.1 Standby

When the BMS is well-connected, and the battery is not in over/under voltage, over current, short circuit or high/low temperature protection status, press the reset button to activate the BMS. Then the LED indicator lightens in order. And the BMS is in standby status.

At standby status, the running indicator blinks. And the battery pack can be charged and discharged.

### 6.2 Over charging protection and recovery

#### 6.2.1 over charging protection and recovery of individual cell

When an individual cell voltage exceeds the setting over charging protection threshold, BMS enters over charging protection status. And the battery can not be charged.

Conditions to release the over discharge protection status.

1. When the cell voltage decreases to individual cell over charging recovery threshold, and the SOC is lower than 96%.
2. When connected with loads.

#### 6.2.2 Over charging protection and recovery of total voltage

When the pack voltage exceeds the charging over voltage protection

threshold, BMS enters charging over voltage protection. And the battery can not be charged.

Conditions to release the over charging protection status.

1. When the pack voltage decreases to over discharge protection recovery threshold, and the SOC is lower than 96%.
2. When connected with loads.

### 6.3 Over discharge protection and recovery

#### 6.3.1 over discharging protection and recovery of individual cell

Whenever an individual cell voltage lower than the over discharge protection threshold, BMS enters over discharge protection status. And the battery can not be charged. After maintaining communication with inverter for one minutes, the BMS will power off.

BMS can be activate by pressing reset button, or charging. And BMS will detects the voltage and check whether the voltage reaches the recovery threshold.

#### 6.3.2 Over discharging protection and recovery of total voltage

When the pack total voltage decrease to the over discharging protection threshold, discharging MOSFET will be disconnected and battery pack can not be discharged. The BMS enters over discharge protection status. After maintain communication for one minutes, BMS will shut off

automatically.

BMS can be activated by pressing 'reset' button or charging. After being activated, BMS detects the pack total voltage, and check whether the total voltage reach the recovery threshold.

#### 6.4 Over charging current protection and recovery

If the charging limitation function is turned off, the charging over current protection will be activated once the charge current being too large.

When charging current value exceeds the setting over current threshold, and with enough the time delay, BMS enters charging over current protection. And the battery can not be charged.

Two ways to recover from charging over current protection.

BMS will recover charging automatically after a certain time (default time). And detects the charging current value at the same time to check whether the current value reaches recovery threshold.

Charging over current protection can be released by discharging.

#### 6.5 Over discharge current protection and recovery

When the discharging current exceeds over current protection threshold, and with enough time delay, BMS enters discharging over current protection. And the battery can not be discharged.

BMS will recover discharging automatically after a certain time (default

time). And detects the discharging current value at the same time to check whether the current value reaches recovery threshold.

For discharging over current protection, there's transient current and discharge current. The recovery condition is the same. But when the transient over current protection times reaches the lock time threshold, only charging or restarting could release the protection.

## 6.6 Temperature protection and recovery

There are six temperature sensing leads to detects and monitors the temperature in real-time.

### 6.6.1 High temperature protection and recovery

When at the discharging status, any cell temperature (There are four NTC for cell temperature detecting.) exceeds the high temperature protection threshold, BMS enters high temperature protection status. And the battery can not be charged or discharged.

When detecting the cell temperature decreased to high temperature recovery threshold, BMS recovers charging/discharging functions.

### 6.6.2 Low temperature protection and recovery

When at the charging status, any cell temperature decreased to the low temperature protection threshold, BMS enters low temperature

protection status. And the battery can not be charged or discharged.

When detecting the cell temperature exceeds the low temperature recovery threshold, BMS recovers charging/discharging functions.

### 6.6.3 Ambient temperature warning and PCB temperature protection

When detecting the ambient temperature exceeds ambient temperature warning threshold, BMS enters high temperature

## 6.7 Equalization

BMS could balancing individual cell at standby and charging mode through power consumption circuit. When any individual cell voltage is higher than equalization start voltage and the voltage difference exceeds the threshold, the equalization circuit flows. The equalization start voltage threshold is configurable.

When connected with charger or the voltage difference lower than setting threshold, equalization stops.

## 6.8 Power ON/OFF

Item	Function	Definition
1	Power on/Start	BMS can be activated by pressing reset button at sleeping mode. The LED indicators will be lighten one by one. Then the BMS enters running status.
2	Power off/Sleep	BMS will enter sleep mode if hold the reset button for 3 seconds at standby or discharging mode. The LED indicators will blink one by one. Then enters sleep mode.

## 6.9 Storage

BMS comes with data storage module, the data includes protection and warning status, protection and warning recovery time, individual cell voltage, pack cell total voltage, charging/discharging capacity, current and temperature. BMS could record the information of a certain period of time through upper computer system. No less than 300 pieces of information can be stored. And all the data can be saved into your computer as excel files.



### 8. Connections

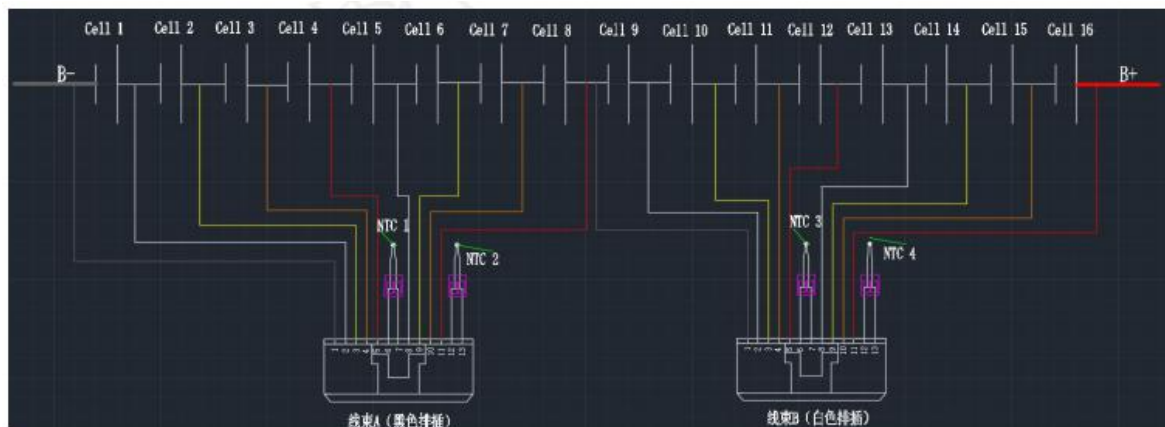
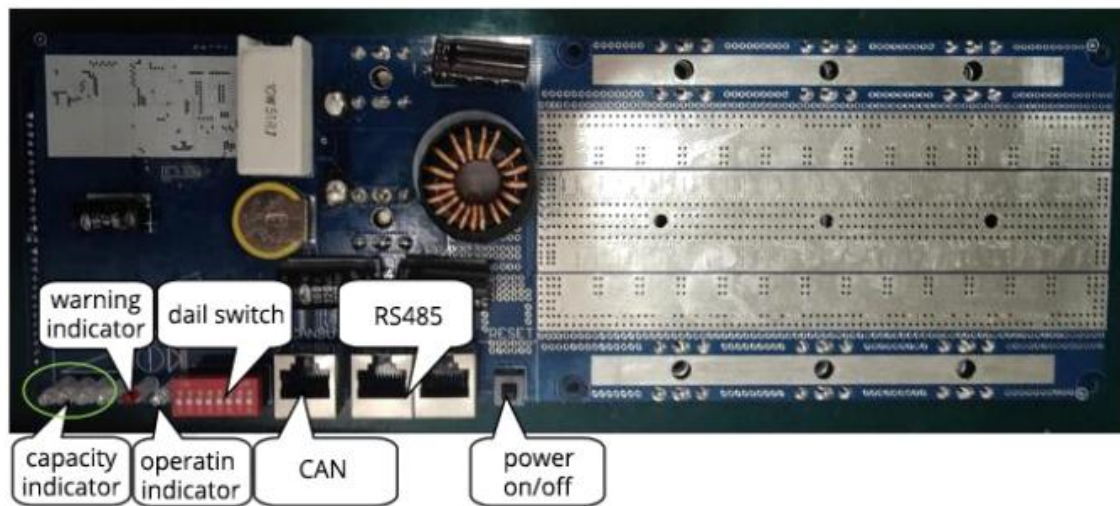
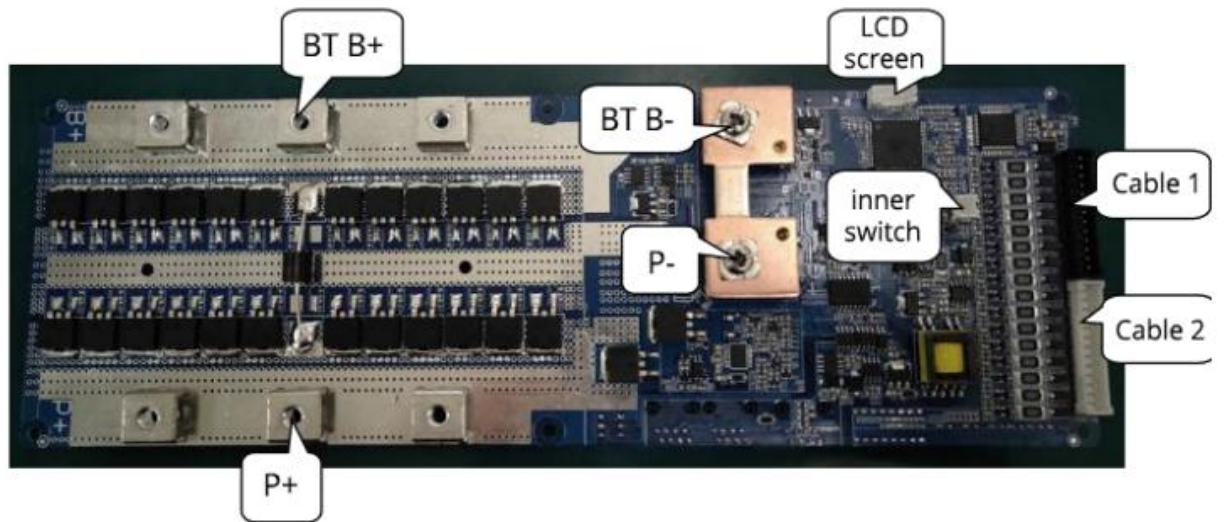

### 8.1 Definition of wiring

Wire Harness A (Black connector)		
	CELL1-	The negative terminals of 1 <sup>st</sup> cell
	CELL1+	The positive terminals of 1 <sup>st</sup> cell
	CELL2+	The positive terminals of 2 <sup>nd</sup> cell
	CELL3+	The positive terminals of 3 <sup>rd</sup> cell
	CELL4+	The positive terminals of 4 <sup>th</sup> cell
	NTC1+	The temperature sensor NTC1
	NTC1-	The temperature sensor NTC1
	CELL5+	The positive terminals of 5 <sup>th</sup> cell
	CELL6+	The positive terminals of 6 <sup>th</sup> cell
	CELL7+	The positive terminals of 7 <sup>th</sup> cell
	CELL8+	The positive terminals of 8 <sup>th</sup> cell
	NTC2+	The temperature sensor NTC2
	NTC2-	The temperature sensor NTC2

Wire Harness B (White connector)		
	CELL9-	The negative terminals of 9 <sup>th</sup> cell
	CELL9+	The positive terminals of 9 <sup>th</sup> cell
	CELL10+	The positive terminals of 10 <sup>th</sup> cell
	CELL11+	The positive terminals of 11 <sup>th</sup> cell
	CELL12+	The positive terminals of 12 <sup>th</sup> cell
	NTC3+	The temperature sensor NTC3
	NTC3-	The temperature sensor NTC3
	CELL13+	The positive terminals of 13 <sup>th</sup> cell
	CELL14+	The positive terminals of 14 <sup>th</sup> cell
	CELL15+	The positive terminals of 15 <sup>th</sup> cell
	CELL16+	The positive terminals of 16 <sup>th</sup> cell
	NTC4+	The temperature sensor NTC3
	NTC4-	The temperature sensor NTC3

Note: CELL8+ and CELL9- connected with the positive terminal of 8<sup>th</sup> cell and negative terminal of 9<sup>th</sup> cell to provide sampling accuracy of cell. And CELL16+ is also the positive terminals of battery pack.

## 8.2 Wiring step

Wiring: B- → WIRE HARNESS A → WIRE HARNESS B → B+ → P+ → charger/loads → P- (After wiring, press the reset button to activate the BMS.)

Disconnection: unconnected charger or loads, turn off the BMS and disconnect WIRE HARNESS B → WIRE HARNESS A → B-

Input and output:

Charging: Connect the positive of charger with BMS P+, and the negative of the charger with BMS P-.

Discharging: Connect the positive of loads with BMS P+, and the negative of the loads with BMS P-.

## 9. Communication

### 9.1 CAN communication

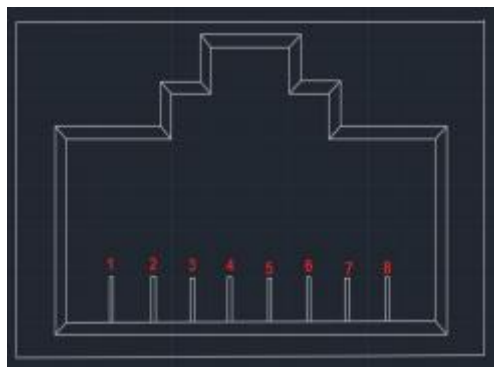

PINS	DEFINITION
1/2/7/8	NC
4	CAN-L
5	CAN-H
3/6	GROUND

## 9.2 RS485 communication

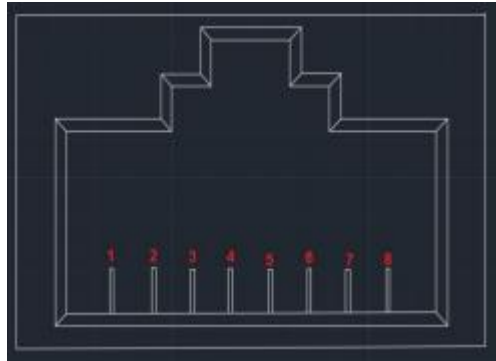

PINS	DEFINITION
1/8	RS485-B
2/7	RS485-A
3/6	GROUND
4/5	NC

## 9.3 Parallel communication

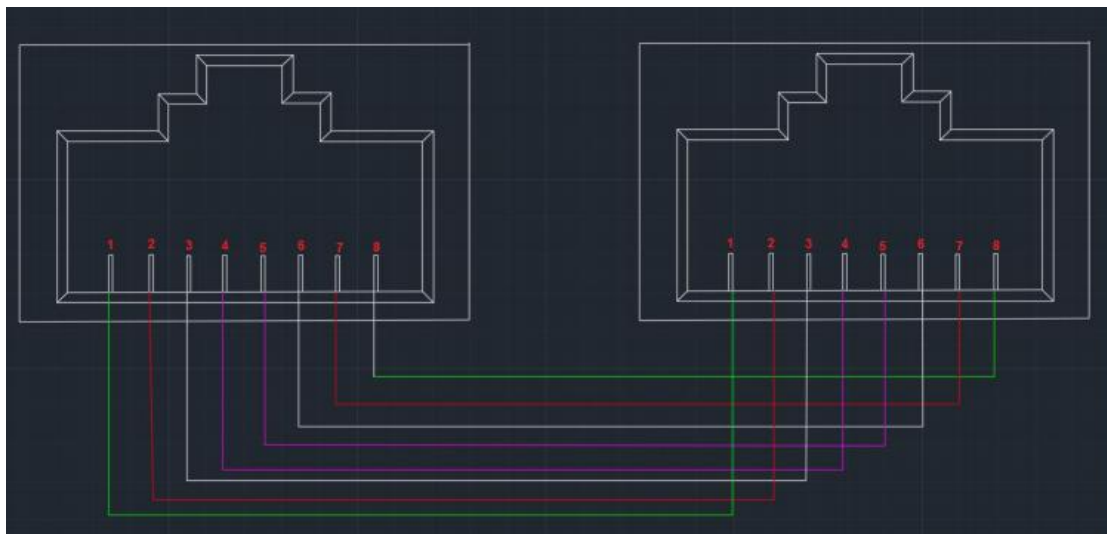

## 9.4 DIP address

DIP ADDRESS: If the battery packs is connected in parallel, the DIP address identifies each pack with different addresses.

Bit 1 to 4 for different address of paralleled packs. Bit 5 to 8 for the

quantity of slave packs.

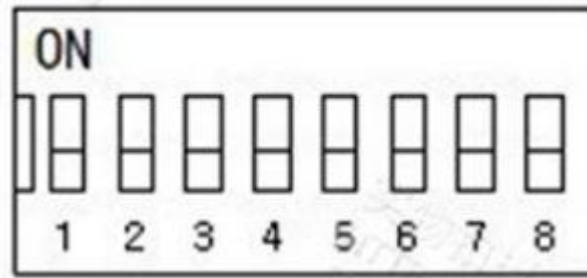

### 9.4.1 RS485 DIP address setup

RS485 Communication								
Single pack address setting: #1, #2, #3, #4, #5, #6, #7, #8 all set OFF								
	8	7	6	5	4	3	2	1
1 <sup>st</sup> PACK	OFF	OFF	OFF	OFF	OFF	OFF	OFF	ON
2 <sup>nd</sup> PACK	OFF	OFF	OFF	OFF	OFF	OFF	ON	OFF
3 <sup>rd</sup> PACK	OFF	OFF	OFF	OFF	OFF	OFF	ON	ON
4 <sup>th</sup> PACK	OFF	OFF	OFF	OFF	OFF	ON	OFF	OFF
5 <sup>th</sup> PACK	OFF	OFF	OFF	OFF	OFF	ON	OFF	ON
6 <sup>th</sup> PACK	OFF	OFF	OFF	OFF	OFF	ON	ON	OFF
7 <sup>th</sup> PACK	OFF	OFF	OFF	OFF	OFF	ON	ON	ON
8 <sup>th</sup> PACK	OFF	OFF	OFF	OFF	ON	OFF	OFF	OFF
9 <sup>th</sup> PACK	OFF	OFF	OFF	OFF	ON	OFF	OFF	ON
10 <sup>th</sup> PACK	OFF	OFF	OFF	OFF	ON	OFF	ON	OFF
11 <sup>th</sup> PACK	OFF	OFF	OFF	OFF	ON	OFF	ON	ON
12 <sup>th</sup> PACK	OFF	OFF	OFF	OFF	ON	ON	OFF	OFF
13 <sup>th</sup> PACK	OFF	OFF	OFF	OFF	ON	ON	OFF	ON
14 <sup>th</sup> PACK	OFF	OFF	OFF	OFF	ON	ON	ON	OFF
15 <sup>th</sup> PACK	OFF	OFF	OFF	OFF	ON	ON	ON	ON

## CAN DIP address set

(#1, #2, #3, #4 set OFF. #5, #6, #7, #8 set as follows)				
Master Pack: the one connected directly with computer				
	8	7	6	5
One pack	OFF	OFF	OFF	OFF
2 packs in parallel	OFF	OFF	OFF	ON
3 packs in parallel	OFF	OFF	ON	OFF
4 packs in parallel	OFF	OFF	ON	ON
5 packs in parallel	OFF	ON	OFF	OFF
6 packs in parallel	OFF	ON	OFF	ON
7 packs in parallel	OFF	ON	ON	OFF
8 packs in parallel	OFF	ON	ON	ON
9 packs in parallel	ON	OFF	OFF	OFF
10 packs in parallel	ON	OFF	OFF	ON
11 packs in parallel	ON	OFF	ON	OFF
12 packs in parallel	ON	OFF	ON	ON
13 packs in parallel	ON	ON	OFF	OFF
14 packs in parallel	ON	ON	OFF	ON
15 packs in parallel	ON	ON	ON	OFF
16 packs in parallel	ON	ON	ON	ON
Slave Packs				
#5, #6, #7, #8 all set OFF. #1, #2, #3, #4 set as follows				
	4	3	2	1
1 <sup>st</sup> slave pack (2 packs in parallel)	OFF	OFF	OFF	ON
2 <sup>nd</sup> slave pack (3 packs in parallel)	OFF	OFF	ON	OFF
3 <sup>rd</sup> slave pack (4 packs in parallel)	OFF	OFF	ON	ON
4 <sup>th</sup> slave pack (5 packs in parallel)	OFF	ON	OFF	OFF
5 <sup>th</sup> slave pack (6 packs in parallel)	OFF	ON	OFF	ON
6 <sup>th</sup> slave pack (7 packs in parallel)	OFF	ON	ON	OFF
7 <sup>th</sup> slave pack (8 packs in parallel)	OFF	ON	ON	ON
8 <sup>th</sup> slave pack (9 packs in parallel)	ON	OFF	OFF	OFF
9 <sup>th</sup> slave pack (10 packs in parallel)	ON	OFF	OFF	ON
10 <sup>th</sup> slave pack (11 packs in parallel)	ON	OFF	ON	OFF
11 <sup>th</sup> slave pack (12 packs in parallel)	ON	OFF	ON	ON
12 <sup>th</sup> slave pack (13 packs in parallel)	ON	ON	OFF	OFF
13 <sup>th</sup> slave pack (14 packs in parallel)	ON	ON	OFF	ON
14 <sup>th</sup> slave pack 15 packs in parallel)	ON	ON	ON	OFF
15 <sup>th</sup> slave pack (16 packs in parallel)	ON	ON	ON	ON

### 10. LCD screen

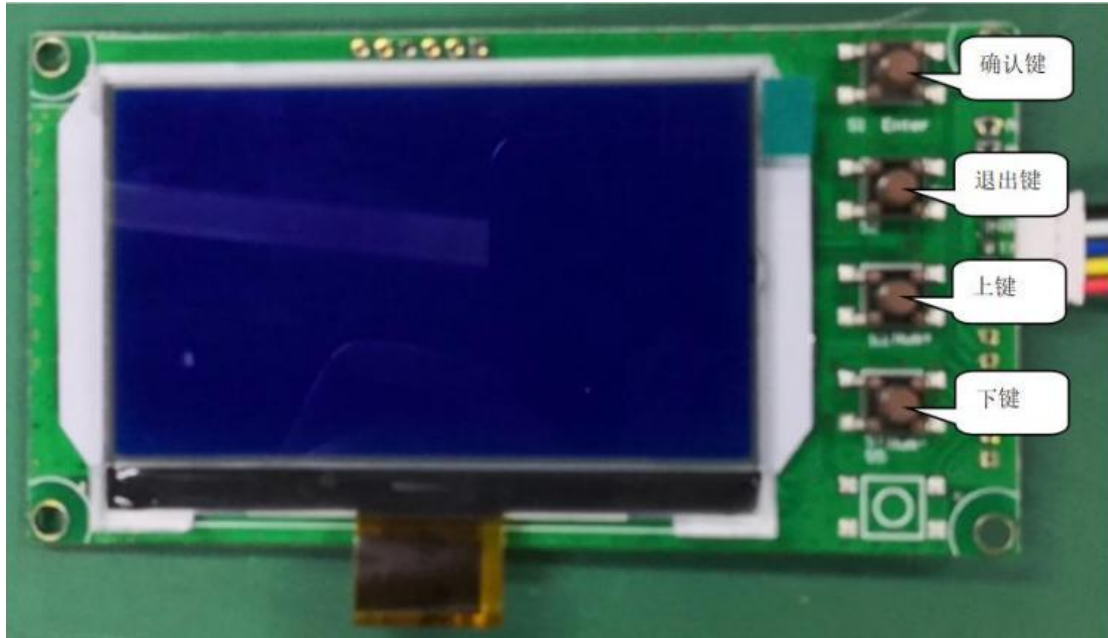

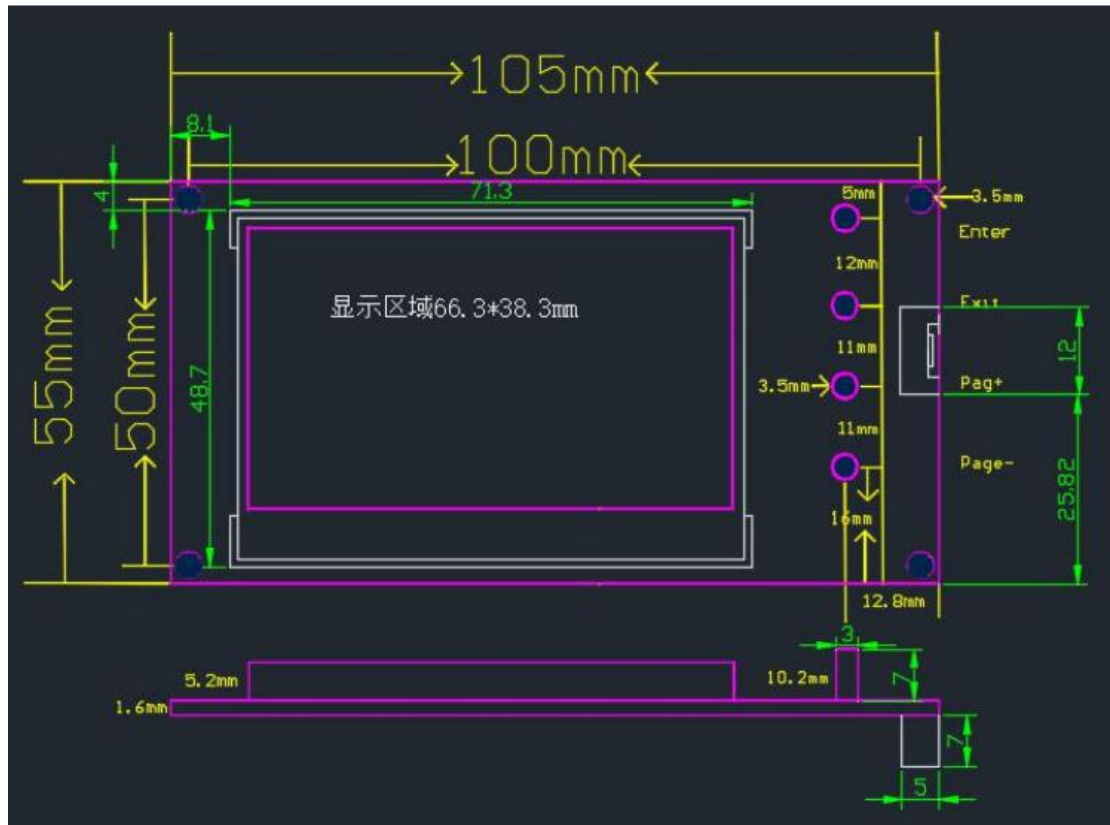

## 11. Precautions

- The BMS can not be connected in series.
- The components of the BMS withstand voltage of 100V most.
- Do not connect the external switch with other devices without permission. Or SEPLoS will not responsible for any damage that cause.
- Do not make any contact with the surface of battery cell when installing. Or the cell may be damaged.
- Do not make any contact with the components of the PCB. Or the PCB may be damaged.
- Operating at dry and dust free room.

- Check if the BMS is correctly connected if no voltage input and output after installation.
- Follow the guidance and use of conditions specified in the data sheet.
- All right reserved.



**SEPLoS**

*FOR BETTER LIFE*

This document is subject to change without notice.

©2021 SEPLoS Technology

Room 1611, building 49, No. 3 Yunfeng Road, Queshan, Taoyuan Apartment, Dalang Street, Longhua New District, Shenzhen China

TEL : (86) 13286686628

E-mail: info@seplos.com

<http://www.seplos.com>